

DIY

powered by **hypex electronics**

/CLASS D

Assembly Instructions

Nilai⁵⁰⁰ DIY

Stereo kit

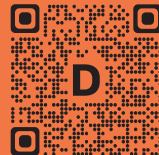

Assembly video
Scan me!

Table of Contents

Chapter	Page
Tools	2
Parts	2
Introduction	5
User Instructions	5
Safety precautions	6
Assembly	7
Result	7
Case	8
Amplifiers & Supply	9
Backpanel	11
Cables	15
Lid & Frontpanel	18
System information	21
Troubleshooting & Support	22
Warranty & Disclaimer	23
Revisions	23
Notes	23

Tools

Not included:

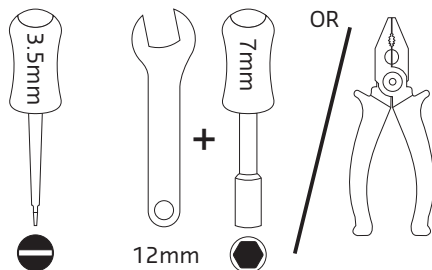

Included:

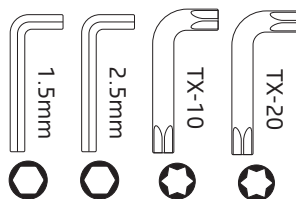

Parts

Electronics

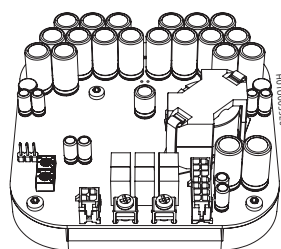

2x EL-1 Nilai500DIY

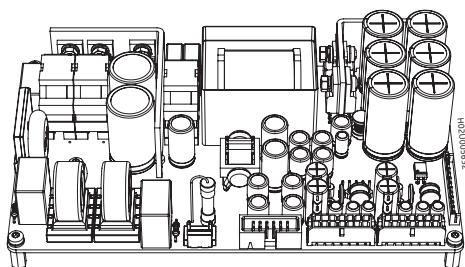

1x EL-2 PS500DIY



1x EL-3 Switch

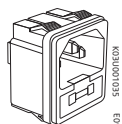

1x EL-4 Terminal



1x EL-5 Control Front



1x EL-6 Control Back



1x EL-7 Right Input

Case

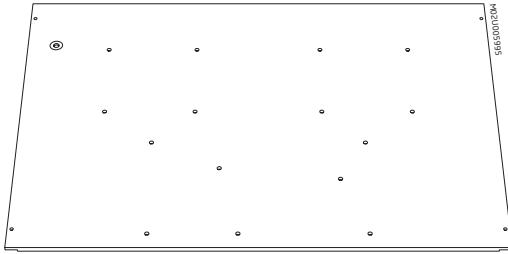

1x CA-1 Bottom

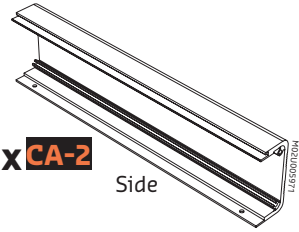

2x CA-2 Side



4x CA-3 Feet

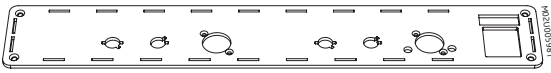

1x CA-4 Back



Not used:
4x M3x7

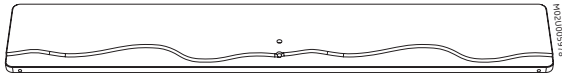

1x CA-5 Front

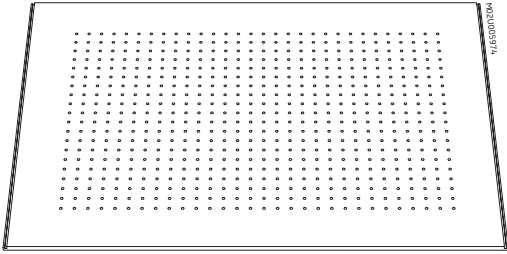

1x CA-6 Top

Mounting set Case

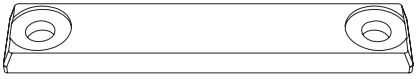

2x MC-1



5x MC-2



4x MC-3



8x MC-4



1x MC-5



1x MC-6



1x MC-7



4x MC-8



4x MC-9



2x MC-10

1485001204

Cable set

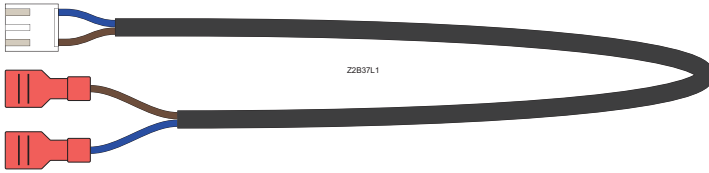

1x **CB-1**



1x **CB-2**



1x **CB-3**



1x **CB-4**

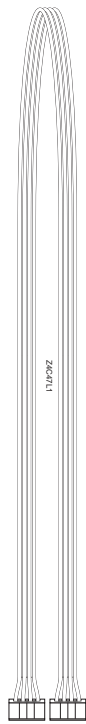

1x **CB-5**

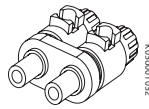

2x **CB-6**



2x **CB-7**



2x **CB-8**



2x **CB-9**

K0210005919

Mounting set



4x **MS-1**



2x **MS-2**



15x **MS-3**

F34000588

Nilai® 500 DIY Stereo kit, a brief introduction

Thank you for purchasing the Nilai®500DIY Amplifier kit, powered by our Nilai® technology.

The Nilai® amplifiers and the Switch Mode Power Supply used in this kit are:

- Nilai®500DIY (2x)
- PS500DIY (1x)

This stereo kit can be a power amp for your passive loudspeakers. We offer two kind of kits:

- Nilai®500DIY Mono kit 1x500W
- Nilai®500DIY Stereo kit 2x250W

Please read the safety instructions on the next page before assembling, installing and/or operating the Nilai® stereo kit.

Please note the different models. This assembly instruction describes how to assemble one of these models. The mono and stereo kit only offer balanced inputs. If your source only offers unbalanced outputs you can use one of our interconnects to connect them properly.

This assembly instruction covers the general assembly instructions for this specific model. For detailed technical information about the used modules please refer to the datasheet on our website.

Included in the kit

- Full Hypex DIY case
- 2x Nilai® Amplifier
- Switch Mode Power Supply
- Full internal cable harness
- All required connectors
- All required mounting materials
- 1x TX-10 / TX-20 / 1.5 and 2.5mm hex key
- This assembly instruction

Not included in the kit

- Power cable
- Loudspeaker cables
- Interconnects
- Tools as described on page 2

User Instructions

Power On/Off

Use the power switch at the back to turn on and off the mains power. When turned on, the device will remain in stand-by mode until activated by the front switch or the trigger input.

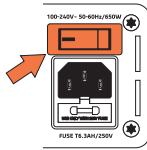

12V Trigger

This 3.5mm mini-jack connection allows you to create a network between all of your DIY classD amplifiers for a more seamless power up and standby experience. When the amplifiers are in standby mode and you turn on the preamplifier, the connected devices will turn on automatically.

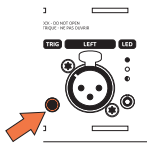

Input Gain Jumper

The Amplifier Modules contain a pinheader (J200) with jumper to alter the input gain setting:

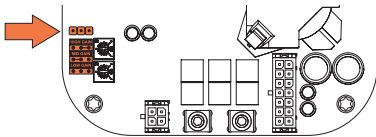

Front Switch

The front switch can be used to turn on and turn-off (standby) the power amplifier when the 12 Volt trigger option is not used (when used, the 12V trigger overrules the front switch).

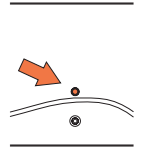

LED Switch

Adjust the brightness of the power indicator light at the front:

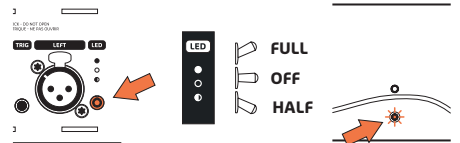

Position	Function		Remarks
Open	Low gain	11.8 dB	Overall gain is set to 11.8dB (3.9x)
1 - 2	Mid gain	21.8 dB	Overall gain is set to 21.8dB (12.3x)
2 - 3	High gain	27.8 dB	Overall gain is set to 27.8dB (24.5x)

Safety precautions

This unit operates at mains voltage and carries hazardous voltages at accessible parts. These parts may never be exposed to inadvertent touch. Observe extreme care during installation and never touch the internal modules while the unit is connected to the mains. Disconnect the unit from the mains and allow all capacitors to discharge for 10 minutes before handling it.

Damage due to inappropriate handling is not covered by warranty. This product has no user-serviceable parts.

Warning: To reduce the risk of fire or electric shock, do not expose this device to rain or moisture.

Précautions de sécurité

Ce unité est sous tension secteur et certaines de ses pièces accessibles sont sous une tension dangereuse. Ces pièces doivent dans tous les cas être protégées contre contacts accidentels. Lors de l'installation, une prudence extrême s'impose. Ne jamais toucher les pièces du module quand celui-ci est relié au secteur. Isoler l'appareil du secteur et attendre 10 minutes pour laisser à tous les condensateurs le temps de se décharger avant de le manipuler.

Les dommages causés par un usage non approprié sont exclus de la garantie. Ce produit ne contient aucune pièce devant être entretenue par l'utilisateur.

Avertissement: Pour réduire les risques de choc électrique, ne pas exposer cet appareil à la pluie ou l'humidité.



Attention: Observe precautions for handling electrostatic sensitive devices. This module uses semiconductors that can be damaged by electrostatic discharge (ESD).



The lightning flash with arrowhead symbol within an equilateral triangle is intended to alert the user to the presence of uninsulated "dangerous voltage" within the product's enclosure, that may be of significant magnitude to constitute a risk of electric shock to persons.



The exclamation point within an equilateral triangle is intended to alert the user of the presence of important operating and maintaining (servicing) instructions in the literature accompanying the appliance.



Use a grounded electrical outlet for this appliance.



Utilice un tomacorriente con conexión a tierra para este aparato.



使用此设备的接地电源插座



Utilisez une prise électrique mise à la terre pour cet appareil.



Verwenden Sie für dieses Gerät eine geerdete Steckdose.



Gebruik voor dit apparaat een geaard stopcontact.

1. Read these instructions.
2. Keep these instructions.
3. Heed all warnings.
4. Follow all instructions.
5. Do not use this apparatus near water.
6. Clean only with a dry cloth.
7. Natural convection should not be impeded by covering the module (apart from the end applications housing). Do not block any ventilation openings. Install in accordance with the manufacturer's instructions.
8. Do not install near any heat sources such as radiators, heat registers, stoves, or other apparatus (including amplifiers) that produce heat.
9. Do not defeat the safety purpose of the protective earth / grounding mains inlet. Protective earth is provided for your safety.
10. Protect the power cord from being walked on or pinched particularly at plugs, convenience receptacles, and the point where they exit from the apparatus.
11. Only use attachments/accessories specified by the manufacturer.
12. Unplug this apparatus during lightning storms or when unused for long periods of time.
13. Refer all servicing to qualified service personnel. Servicing is required when the apparatus has been damaged in any way, such as power-supply cord or plug is damaged, liquid has been spilled or objects have fallen into the apparatus, the apparatus has been exposed to rain or moisture, does not operate normally, or has been dropped.
14. This apparatus shall not be exposed to dripping or splashing, and no object filled with liquids, such as vases or beer glasses, shall be placed on the apparatus.
15. Do not overload wall outlets and extension cords as this can result in a risk of fire or electric shock.
16. This apparatus has been designed with Class-I construction and must be connected to a mains socket outlet with a protective earthing connection.
17. This apparatus has been equipped with a rocker-style AC mains power switch. This switch is located on the rear panel and should remain readily accessible to the user.
18. The MAINS plug or an appliance coupler is used as the disconnect device, so the disconnect device shall remain readily operable.
19. Do not run any cables across the top or the bottom of the module. Apply fixtures to cables to ensure that this is not compromised.
20. Before using this product, ensure all cables are correctly connected and the power cables are not damaged. If you detect any damage, do not use the product.
21. Changes or modifications not expressly approved by Hypex Electronics will void compliance and therefore the user's authority to operate the equipment.
22. Service or modifications by any person or persons other than by Hypex Electronics authorized personnel voids the warranty.



Correct disposal of this product: This symbol indicates that this product should not be disposed of with your household waste, according to the WEEE directive (2012/19/EU) and your national law. This product should be handed over to an authorized collection site for recycling waste electrical and electronic equipment (EEE). Improper handling of this type of waste could have a possible negative impact on the environment and human health due to potentially hazardous substances that are generally associated with EEE. At the same time, your cooperation in the correct disposal of this product will contribute to the effective usage of natural resources. For more information about where you can drop off your waste equipment for recycling, please contact your local city office, waste authority, or your household waste disposal service.

Assembly

Result:

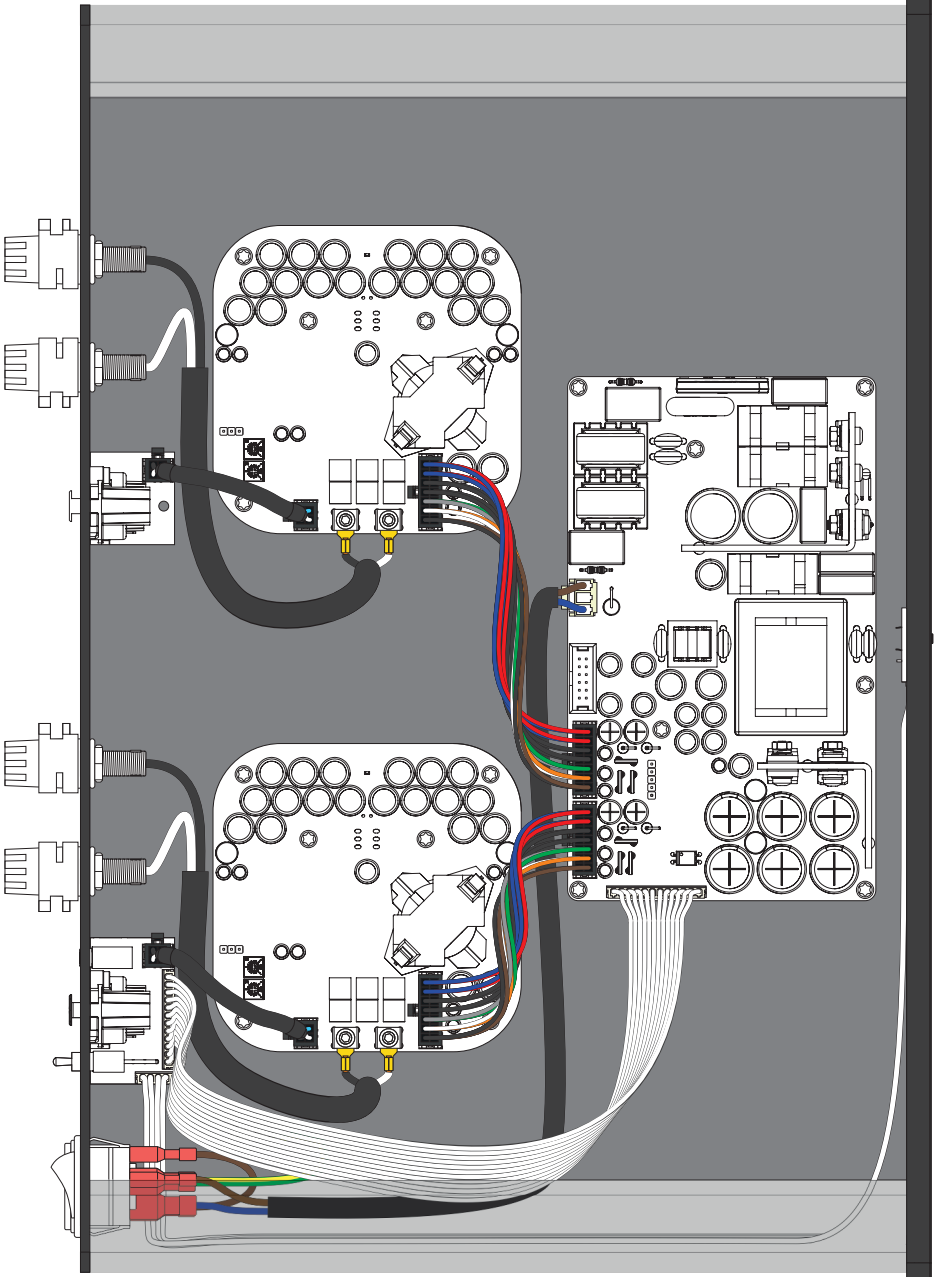

Case

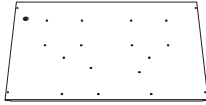

1x **CA-1**



4x **CA-3**

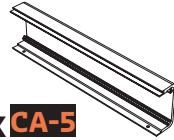

2x **CA-5**



2x **MC-1**



4x **MC-3**



4x **MC-4**



4x **MC-8**



4x **MC-9**

1

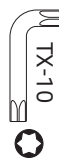
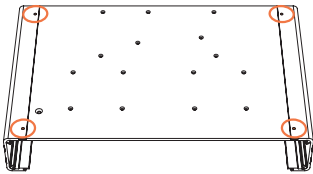

4x **MC-8**

4x **MC-9**

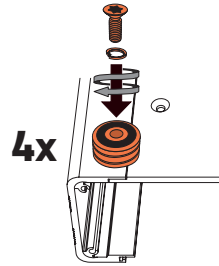

2

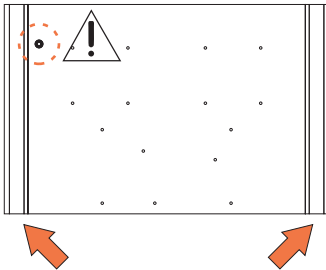

4x **MC-4**

4x **MC-3**

2x

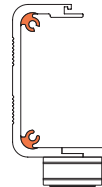
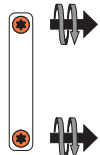
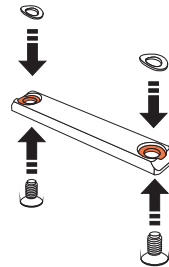

Amplifiers & Supply

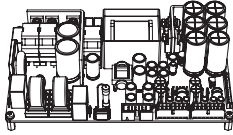
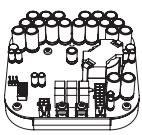

2x **EL-1**

1x **EL-2**



M3x8

15x **MS-3**

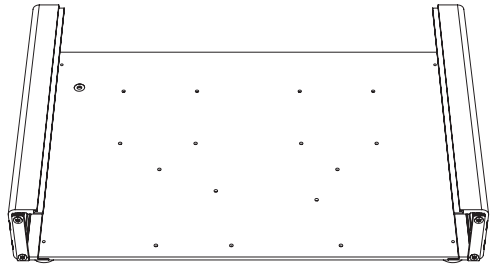

1

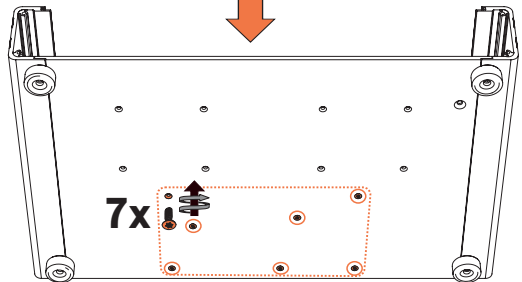
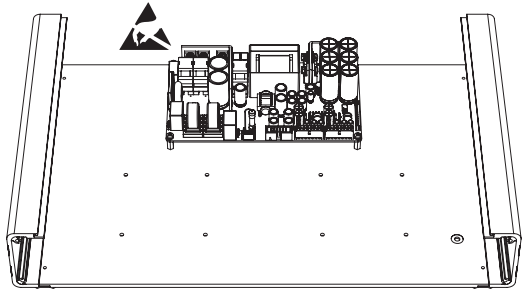
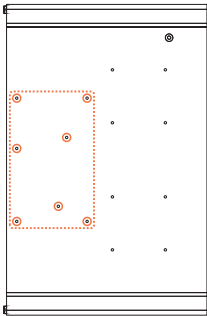

7x **MS-3**

2

Optional

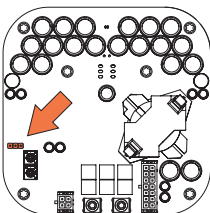

J200



Read user instructions for details.

3 **Optional** If present, remove foil.

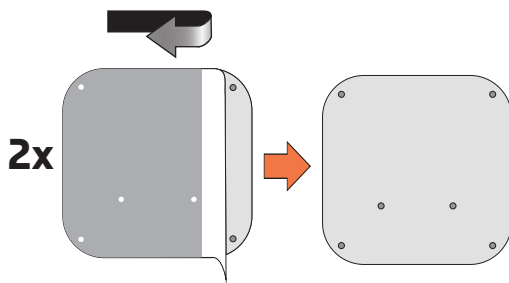
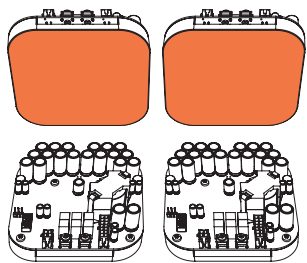

4

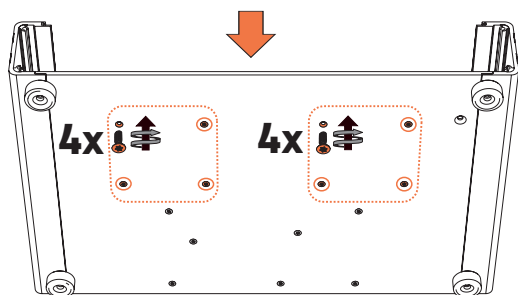
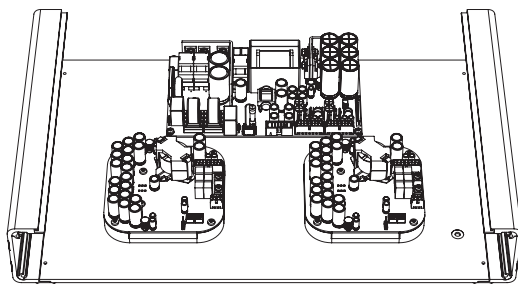
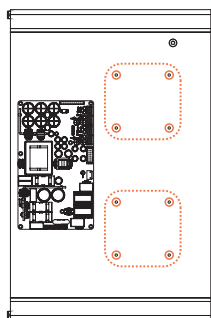

Backpanel

1x **CA-4**

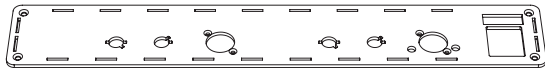

M4x10

4x **MC-2**



4.5mm

4x **MC-4**



2.9x9.5

4x **MS-1**



1x **EL-3**



1x **EL-4**

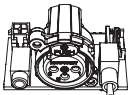

1x **EL-6**



1x **EL-7**



1x **CB-2**



1x **CB-3**

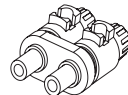

2x **CB-6**



2x **CB-7**

1

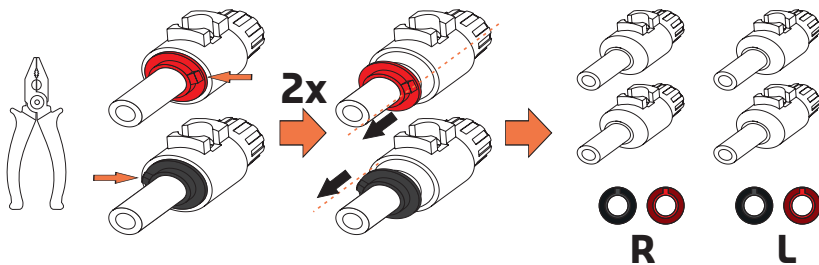
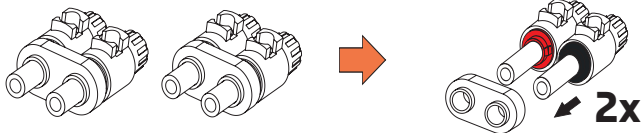

2



R+L

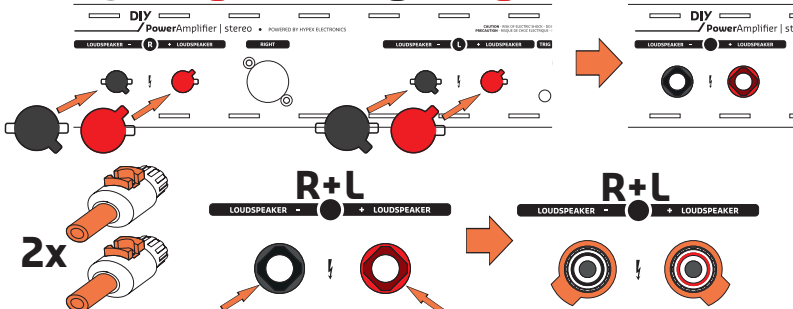

3

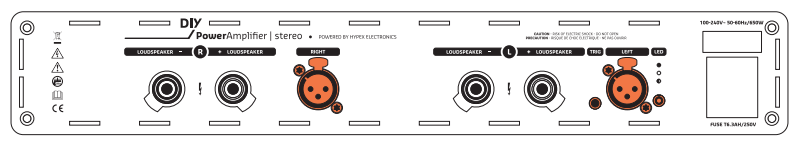
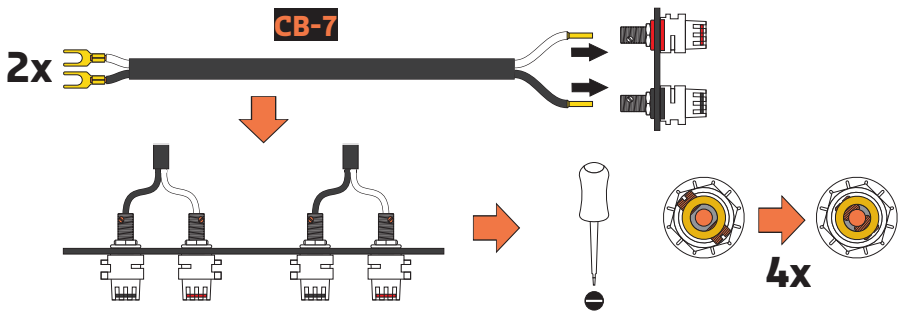
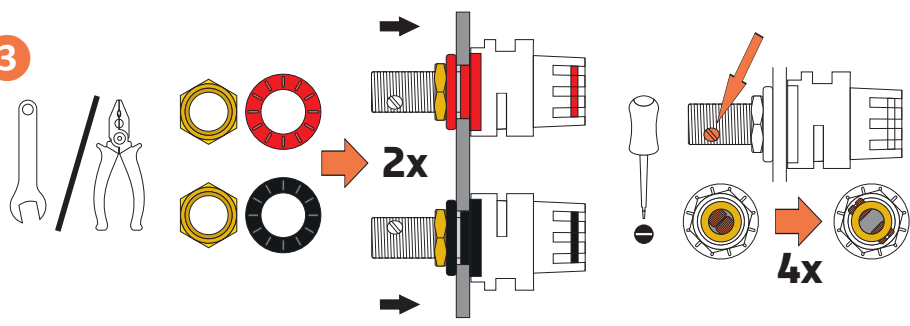

4

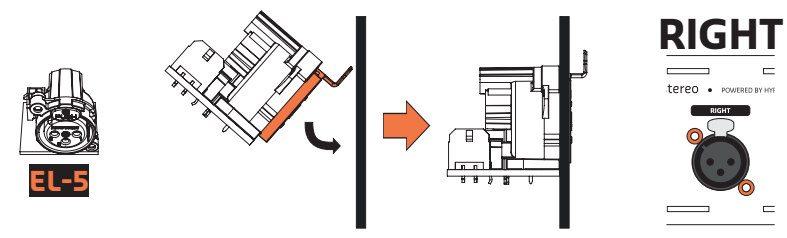

5

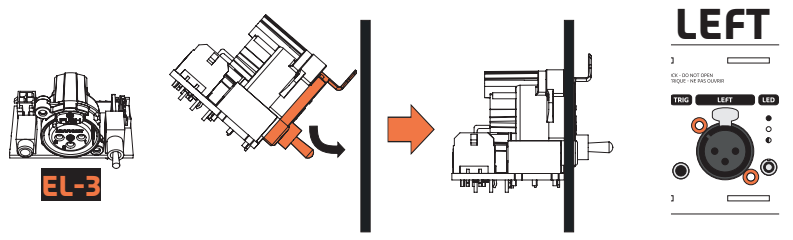

6

4x **MS-1**

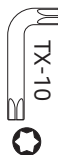

4x

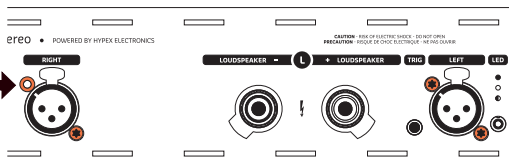

7

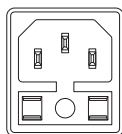
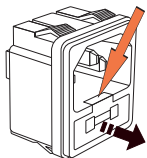

8

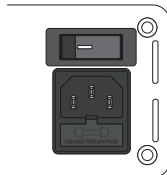
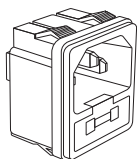
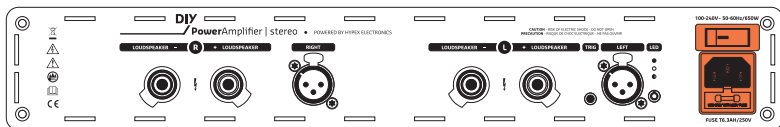

9
10
11

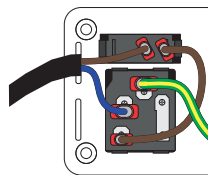

9

CB-2

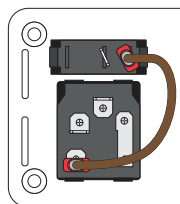
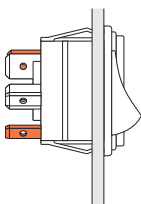
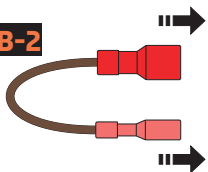

10

CB-3

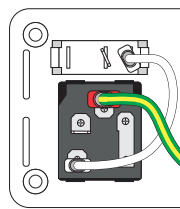
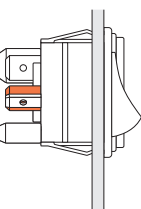
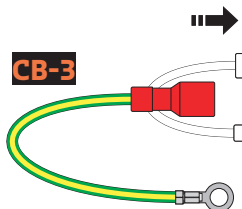

11

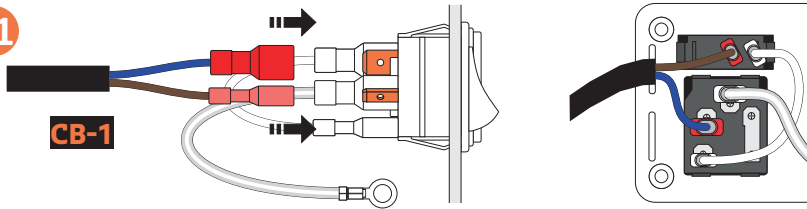

12

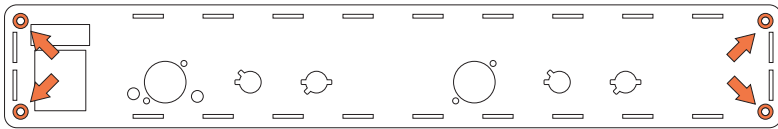

13

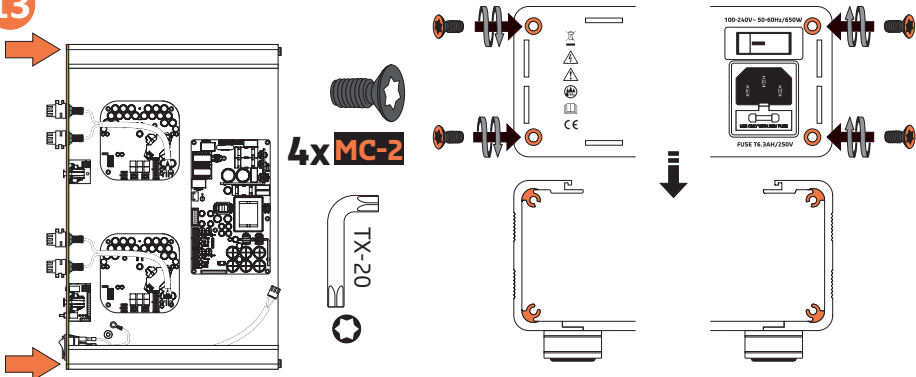

Cables



1

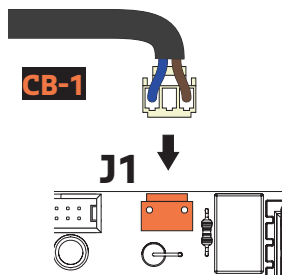
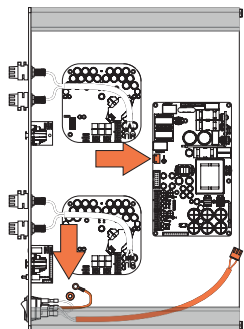

2

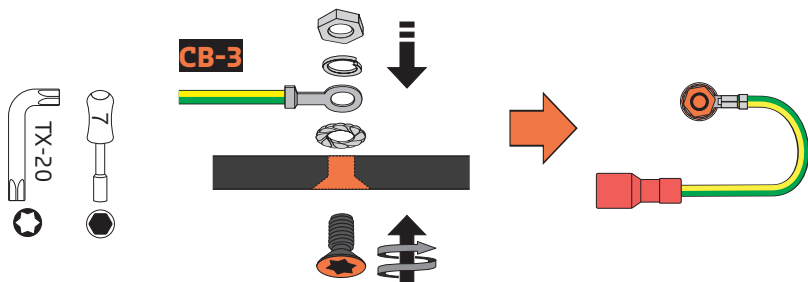

3

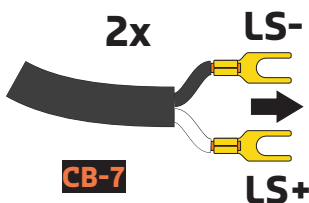
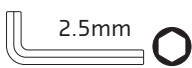
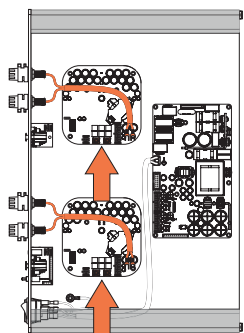

R+L

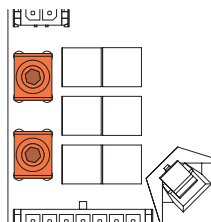

CB-5



4

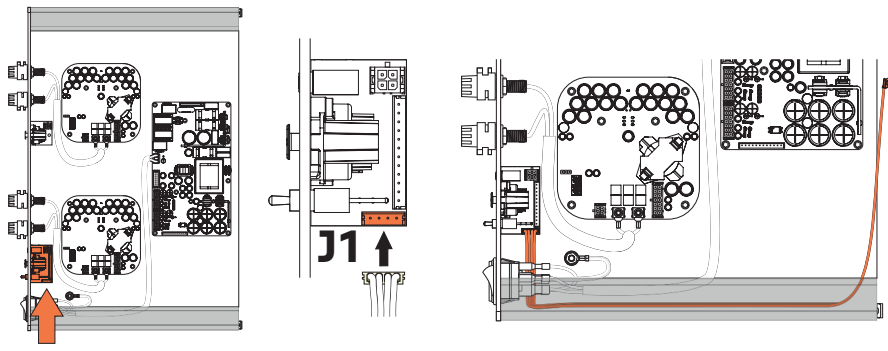

CB-4

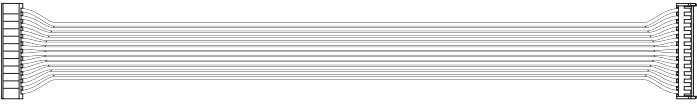

5

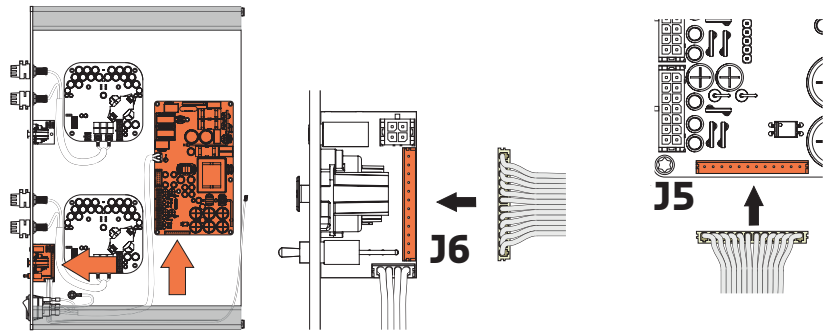

2x CB-8



6 L

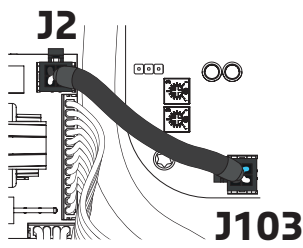

7 R

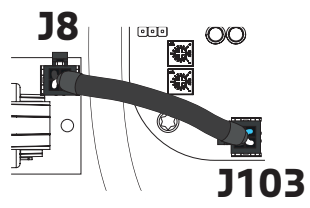

2x CB-9

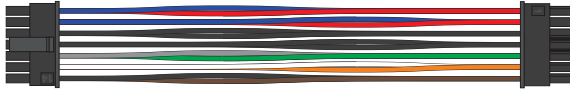

8

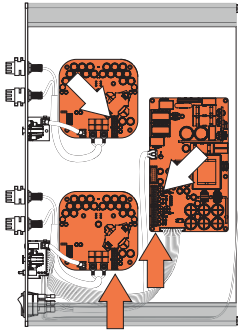
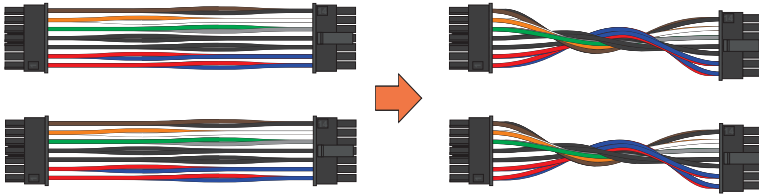

9 L

J100

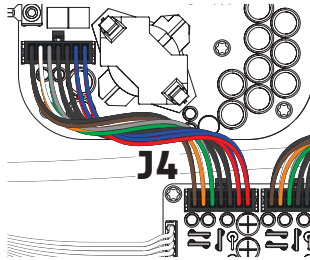

10 R

J100

J3

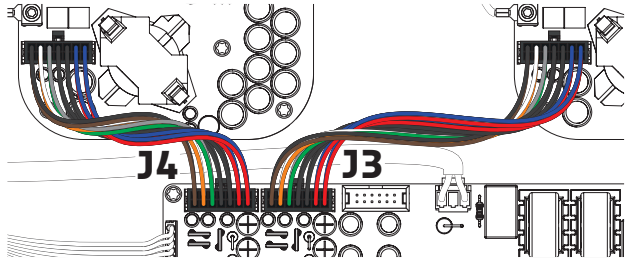

Front & Lid

2x **MC-10**



M3x5



2x **MS-2**

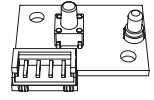

1x **EL-5**

1x **CA-5**

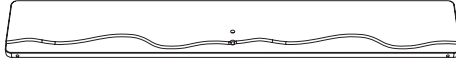

1

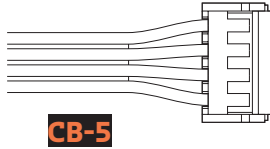
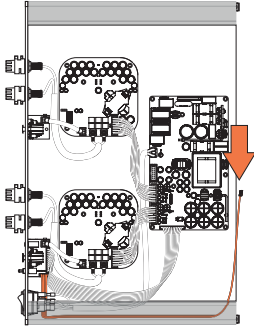

CB-5



J1

EL-5

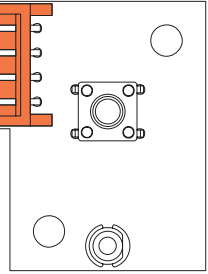

2

2x **MC-10**



1.5mm

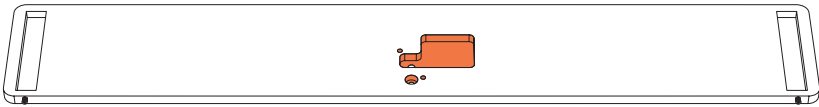
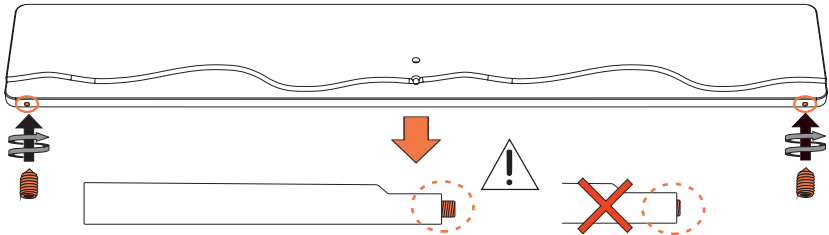

3



MS-2

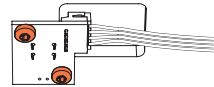
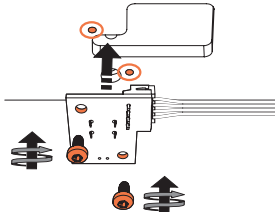
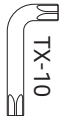

1x CA-6

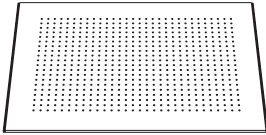

4

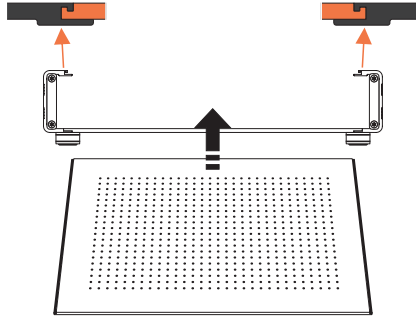
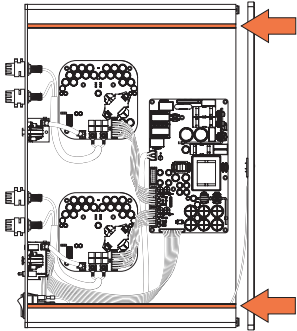

5

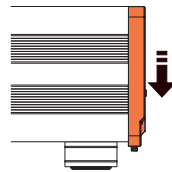
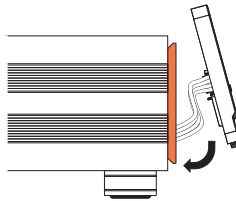
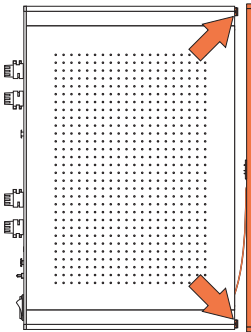

6

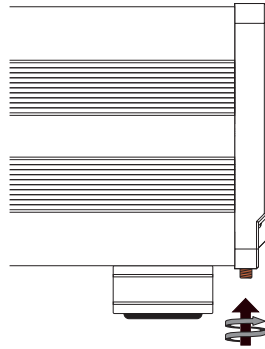
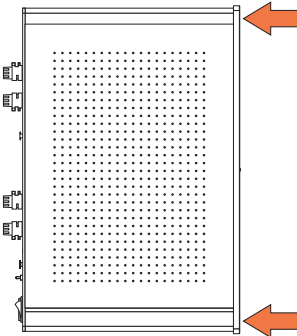

2x

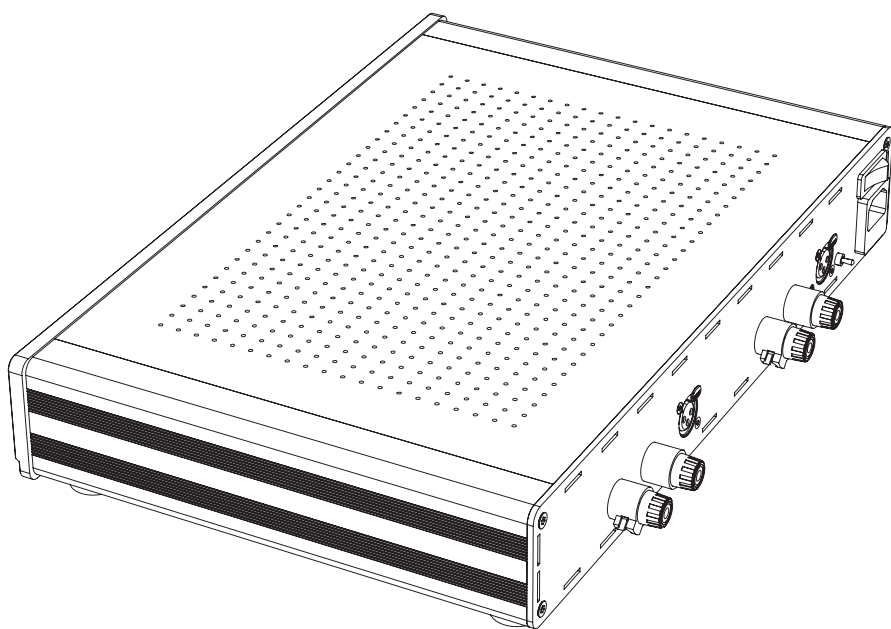
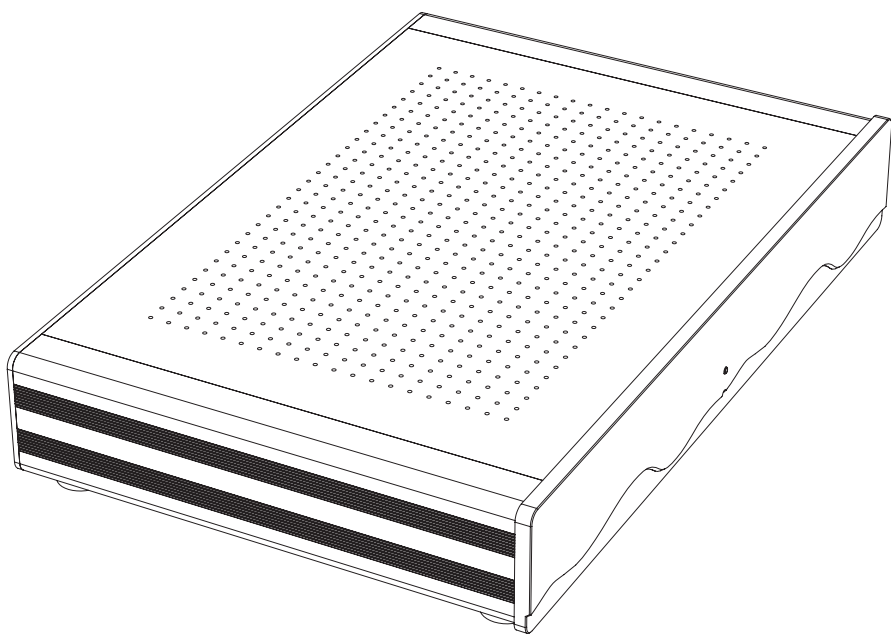

System information Nilai® 500 DIY Stereo kit

Technology: Nilai® **Channels:** 2

Line input power:

Line input voltage: 100 - 240Vac*
Line input frequency: 47 - 63 Hz
Connector: 3-pin IEC 250Vac, 10A male

Trigger connection:

Jack 3.5mm (1/8") TS
Min: 6Vdc
Max: 18Vdc

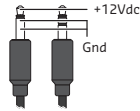

Input power: Depending on load, 650W max

Input sensitivity: Low gain: 12.0V_{rms}
Mid gain: 3.8V_{rms}
High gain: 1.9V_{rms}

Input impedance: 100kΩ

Input connections: 2x Mono XLR (Balanced)

Pinout Pin 1: Shield
Pin 2: Positive (+ or hot)
Pin 3: Negative (- or cold)

Output power per channel:

In 4Ω @ 1% THD+N: 300W
In 8Ω @ 1% THD+N: 260W

Output impedance: 850μΩ @ f < 20kHz
90μΩ @ f < 1kHz

Output connections: 2x Dual Bindingpost

Distortion: 0.0005%
(@ 20Hz < f < 20kHz, 4Ω, P<100W)

Operation:

Load impedance: min 1Ω
Source impedance: max 1kΩ

Performance:

Power Bandwidth: min 35kHz
Frequency Response:
max 70kHz @ +0/-3.0dB. All loads
max 30kHz @ +0/-0.1dB. All loads

Voltage Gain: Low (J200 = open): 11.86dB
Mid (J200 = 1-2): 21.75dB
High (J200 = 3-4): 27.88dB

Dimensions and weight:

External size (WxHxD): 420 x 80 x 300 mm
(size incl feet, excl connectors)
Weight (For the total assembled kit): 5.6kg

For more detailed information please refer to the datasheet of each individual product on our website.

* Operation beyond these limits may result in irreversible damage.

Additional system information

Connecting your Amplifier

DIYclassD Interconnects are the perfect link between the Nilai®500 DIY Stereo kit and pre-amplifiers or active Fusion Amp powered loudspeakers.

The connectors are silver or rhodium plated to guarantee an optimal, uncolored signal transmission.

DIYclassD Interconnects are the best protected audio signal cables in the industry because of their Silver-plated conductors with PTFE tape-wrapped insulation, glass-fibre stabilizers and two layers of braided shield over a bonded carbon triboelectric charge drain layer.

The DIYclassD Interconnects are Custom-made double shielded twisted-pair cables, specifically designed for the highest RFI immunity and lowest microphonic noise. Connecting your audio devices with High-End cables can now be done at a very affordable price.

Visit our webshop at
www.diyclassd.com/products/interconnects/

or scan the QR-code.

Interconnect

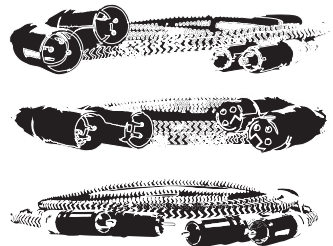

Frequently asked questions

Q I do not have any technical experience, can I build this amplifier kit myself?

A Yes! even without any technical experience you can build your own amplifier kit.

Q Do I need to solder anything?

A No! We have pre-fixed everything for you. It's just a matter of assembling all the parts with a few basic tools.

Q Do you offer a pre-assembled Amplifier kit?

A No, we only offer a DIY building kit. We do not offer any further assembly services.

Q Does this Amplifier kit work with my PreAmplifier?

A In basic this Amplifier works with all PreAmplifiers with the right connections, certainly DIYclassD PreAmplifier kits.

Q What kind of quality can I expect from this DIY Amplifier kit?

A This kit contains Hypex Electronics Nilai® amplifier technology, currently this is Hypex Electronics best sounding amplifier technology.

Troubleshooting

No power

- Check the power outlet.
- The AC-Terminal fuse may be blown. Disconnect power cables and determine its status. If blown: check all AC-cables for damage and correct connections and fix problems. Replace the fuse with a corresponding one.
- The internal fuse may be blown. This fuse is not user replaceable. Please contact Hypex Electronics for more information about service and repair.

No Sound

- A protection might be triggered. Is the module overheated? Try cycling the mains power.
- Check the volume and mute settings.
- Check optional trigger connections.
- Check the source signal.
- Check all the cables.

Poor sound or noise

- Check if the signal is not inverted. Inverted signals might cause one of your speakers to be out-of-phase.
- Is the amplifier clipping?
- Check all connections.

Hum

- Use balanced connections for best system performance.
- Use grounded wall sockets.

Heat

- The Amplifier Kit will get warm/hot when used intensively, this is normal and therefore no reason for concerns.

Balanced/unbalanced connections

- This kit is equipped with balanced inputs. If your source does not provide a balanced output but only an unbalanced output you can use one of our interconnects to connect both properly.

Support

We continuously work to improve your experience with our products. If you have suggestions, remarks or found a bug, please contact us.

If you have any problem with your Amplifier kit please consult this user guide. Do you need additional assistance with assembling your Amplifier kit? Watch our **assembly instruction video** at the product page on our website. (Scan the QR-code at the frontpage for a quick link to the right page.

If neither this user guide or the video are sufficient in order to your problem please contact Hypex support department.

Visit our website!

The latest datasheets and manuals can be found there. Look into our FAQ and if you can not find the answer there, you can also contact us and we will be happy to assist you!

Limited Warranty

DIYClassD.com warrants this device for a period of two years after the original date of purchase against defects due to faulty workmanship or materials arising from normal use of the device. The warranty covers working parts that affect the function of the device. It does NOT cover cosmetic deterioration caused by fair wear and tear, or damage caused by accident, misuse or neglect. Any attempt to modify or take apart the device (or its accessories) will void the warranty.

If you discover a defect, notify DIYClassD.com during the warranty period. Claims under warranty must be supported by reasonable evidence that the date of the claim is within the warranty period. To validate your warranty, please keep your original purchase receipt together with these warranty conditions for the duration of the warranty period. Replacement products claimed under warranty are not entitled to renewed **5-years / 20.000 hours warranty** coverage.

Date of purchase:

Disclaimer

Hypex Electronics BV, its affiliates, agents, and employees, and all persons acting on its or their behalf (collectively, "Hypex Electronics"), disclaim any and all liability for any errors, inaccuracies or incompleteness contained in any datasheet, user guide or in any other disclosure relating to any product.

This Nilai®500 DIY Amplifier kit is designed for use of music reproduction only. No representations are made as to fitness for other uses. Except where noted otherwise any specifications given pertain to this Nilai®500 DIY Amplifier kit only.

LIFE SUPPORT POLICY: Use of Hypex products in life support equipment or equipment whose failure can reasonably be expected to result in injury or death is not permitted except by explicit written consent from Hypex Electronics BV.

Revisions

Revision		Comment	Date
Doc.	HW.		
01	0100	First release	31-10-2022
02	0101	Partnr update, text fix	08-03-2023
03	0101	Clarifications, QR	04-11-2024

Notes

DIY
powered by **hupex electronics**
/CLASSD

Nilai[®]

DIYClassD.com

Kattegat 8

9723 JP Groningen, The Netherlands

+31 50 526 4993

sales@diyclassd.com

www.diyclassd.com

